

Series	Elite
Material	16 Gauge, Type 304 stainless steel
Installation Type	Top mount / Drop-in
Configuration	Single bowl
Finish	Soft satin brushed finish
Overall Dimensions	25" x 22"
Bowl Dimensions	22 1/4" x 16 3/4" x 10"
Drain Size	3 5/8"
Finish Available	Stainless Steel
Minimum cabinet size	27"
Template Included	Yes
Clips Included	Yes
Drain Location	Center
Accessories Included	Strainer and Bottom grid

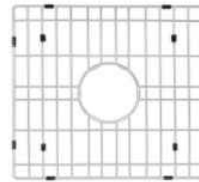

ACCESSORY
Strainer - L-1
Bottom Grid - GR-3212

Stocked Color Options



Stainless Steel

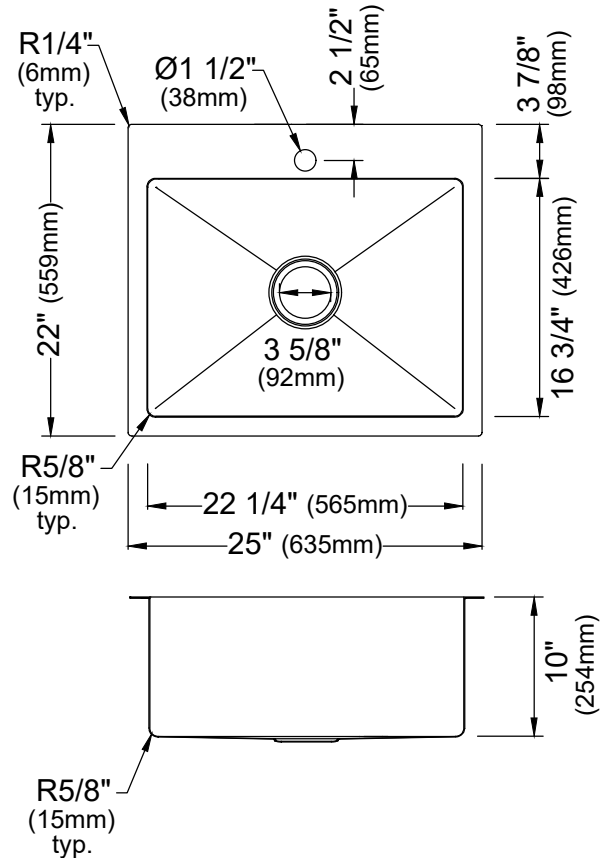

Listing and certifications:
cUPC

Limited lifetime warranty