

Series	Elite
Material	16 Gauge, Type 304 stainless steel
Installation Type	Undermount
Configuration	Double bowl
Finish	Soft satin brushed finish
Overall Dimensions	33" x 22"
Left Bowl Dimensions	12 7/8" x 18" x 10"
Right Bowl Dimensions	16 7/8" x 20" x 10"
Drain Size	3 5/8"
Finish Available	Stainless Steel
Minimum cabinet size	36"
Template Included	Yes
Clips Included	Yes
Drain Locations	Rear
Accessories Included	Strainer (x2) and Bottom grid (x2)

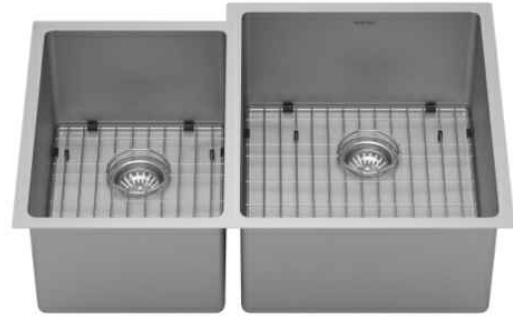

ACCESSORY
Strainer - L-1 x2
Bottom Grid - GR-3201
Bottom Grid - GR-3202

Stocked Color Options



Stainless Steel

Listing and certifications:
cUPC

Limited lifetime warranty

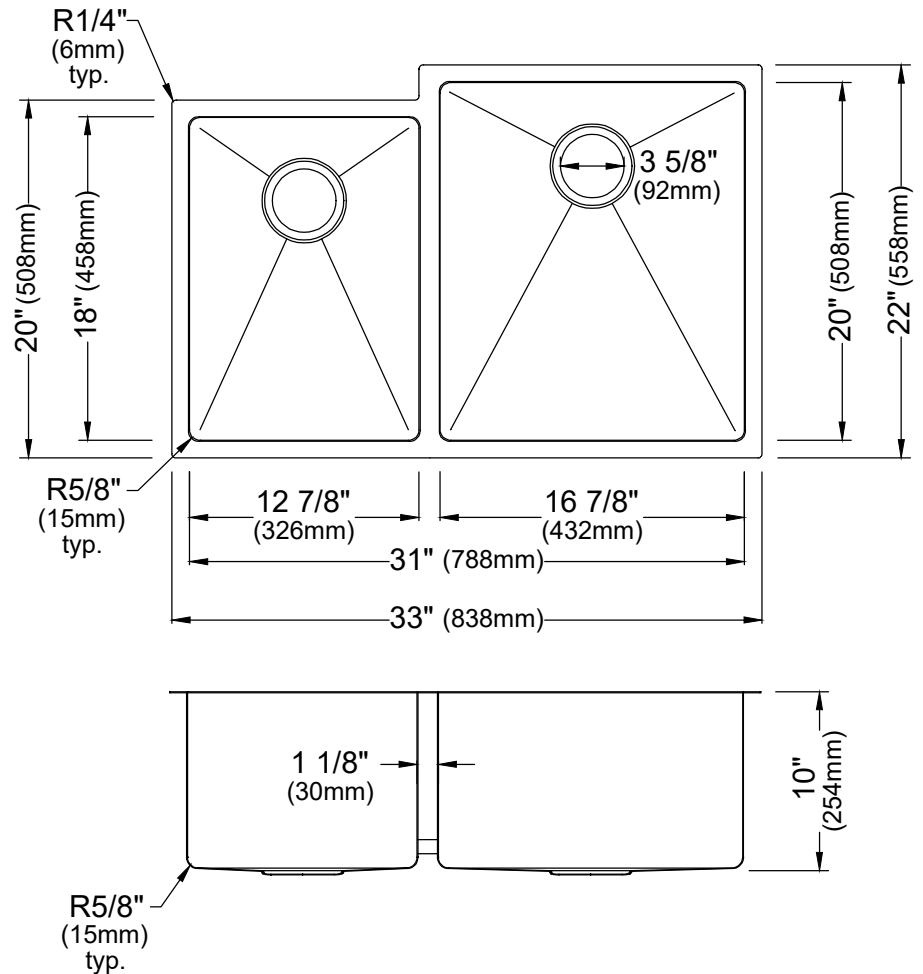

We reserve the right to update product specifications without notice. Please visit karran.com for the most current specification sheets. All dimensions are accurate to 1/4". REV 02-2025