

Series	Select
Material	16 Gauge, Type 304 stainless steel
Installation Type	Undermount
Configuration	Double bowl
Finish	Soft satin brushed finish
Overall Dimensions	30" x 18"
Bowl Dimensions	13 1/2" x 16" x 10"
Drain Size	3 1/2"
Finish Available	Stainless Steel
Minimum cabinet size	33"
Template Included	Yes
Clips Included	Yes
Drain Location	Rear
Accessories Included	Bottom grid (x2) and Strainer (x2)

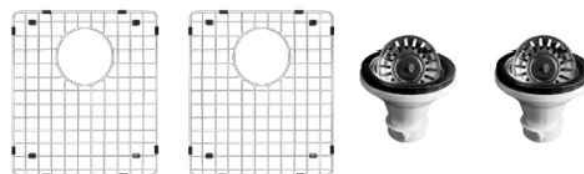

ACCESSORY	
Bottom Grid - GR-3016	x2
Strainer - L-1	x2

Stocked Color Options



Stainless Steel

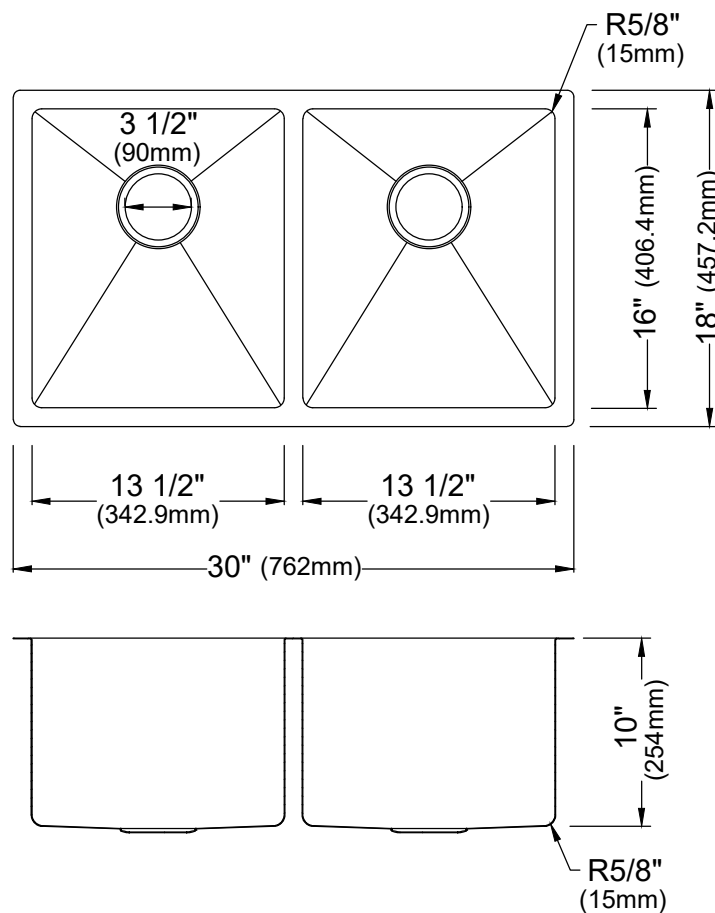

Listing and certifications:
cUPC

Limited lifetime warranty